

01 E2

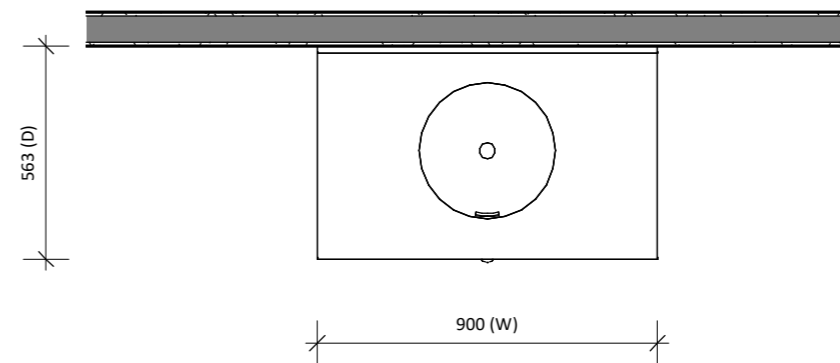

TOP VIEW
scale 1:20

E1
01

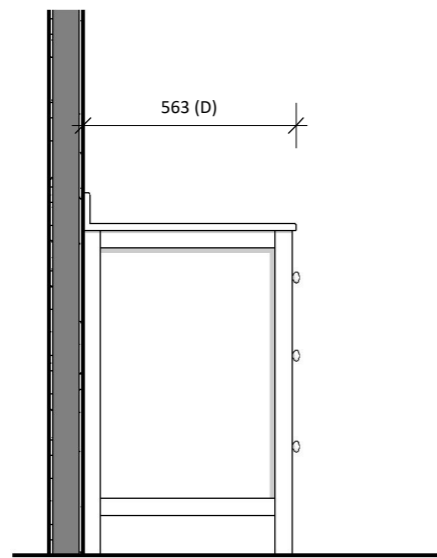

E2 SIDE
01 scale 1:20

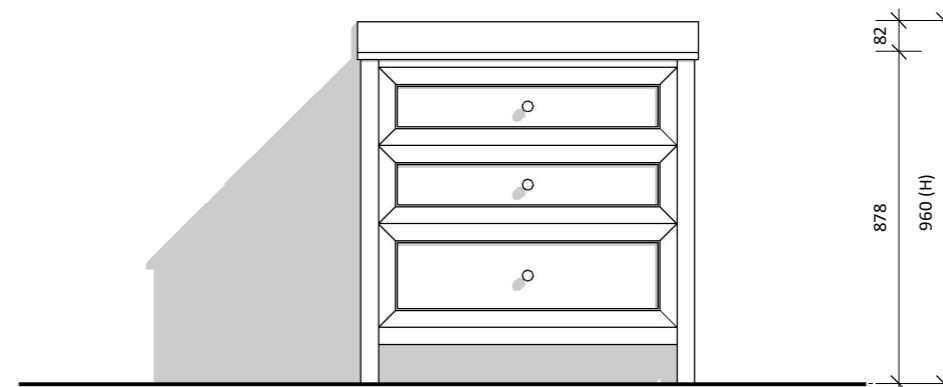

E1 FRONT
01 scale 1:20

Vanity
BY DESIGN

Phone: (07) 3376 6055
Email: enquiries@vanitybydesign.com.au
Address: 241 Monier Road, Darra, Qld 4076
Web: <https://www.vanitybydesign.com.au>

Size: (± 0.5" Tolerance) 900 (W) mm x 563 (D) mm x 960 (H) mm

Cabinet Type: Freestanding

Notes:

- wastes and faucets are not included.
- Vanity unit must be installed by a qualified tradesmen - Failure to do so will void the warranty.
- Plumbing fixtures must be installed by a qualified plumber - Failure to do so will void the warranty.
- Warranty information: 5 years on cabinet & 12 months on top and basin(s).
- Caution boxes may be heavy and will require 2 people to lift.

CHESTER 900