



V

Chantel

collection

20
24

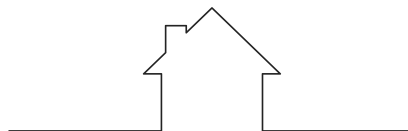

House Collection

Chantel 1200 Single

Chantel 1500 Double

Rubie 460

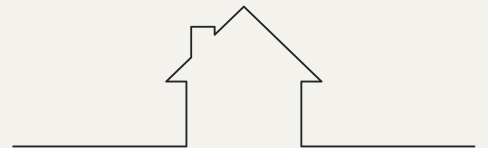

House Collection



Chantel 1500 Double



Chantel 1200 Single



Rubie 460

Cabinet Finish

Choose your paint finish | Custom Paint also available upon request

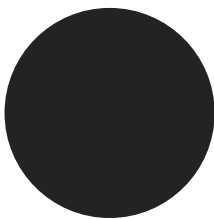

Black

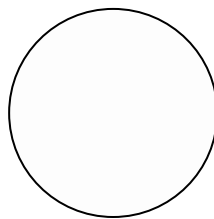

White

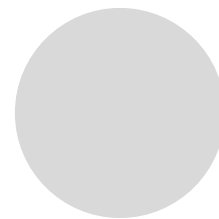

Hampton Grey

Bench Top

Subject to availability and chosen design



Italian Carrara
Natural Marble



Ayla Carrara
Crystalline Silica-Free
(Engineered Stone)



Brushed Gold



Chrome

Handles

Choose a finish



Chantel collection

– a tribute to 1940's glamour and timeless femininity. With a nod to Old Hollywood, each piece showcases craftsmanship and true elegance. This collection embodies a perfect blend of glamour, eclecticism, and a touch of Old Hollywood charm. Elevate your space with Chantel – where style meets nostalgia in an enchanting dance of sophistication.

Chantel 1200 | Single Basin

1500 Length x 560 Depth x 880 Height

Chantel 1500 | Double Basin

1500 Length x 560 Depth x 880 Height

Please Note!

We have some 23' Chantel collection available for immediate pick-up. 23' Stock will have slight differences in overall dimensions!

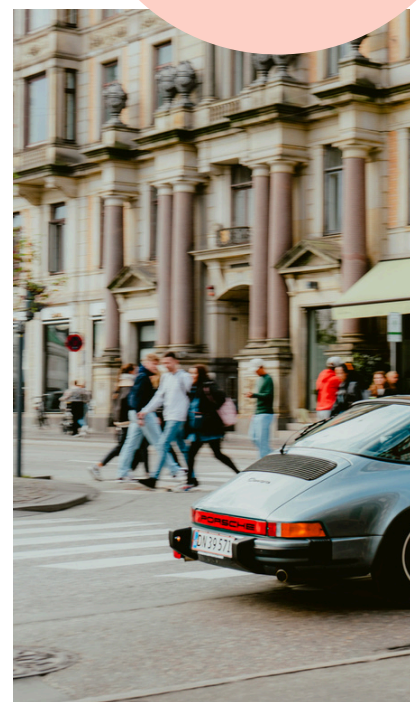
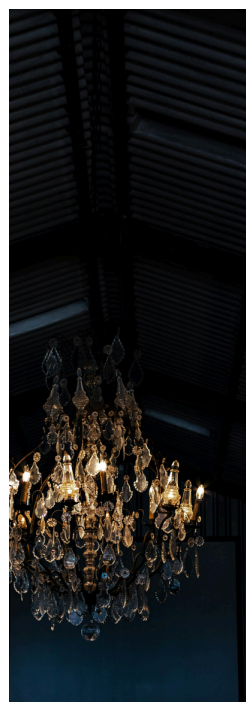



Chantel

Chantel 1200 Single - 2024

Cabinet Size: 1180mm (L) X 550mm (D) X 860mm (H)

Top Size: 1200mm (L) X 560mm (D) X 20mm (H)

Type: Freestanding

Basin: Oval Under-mount Ceramic Basin

Please Note!

We have some 23' Chantel collection available for immediate pick-up. 23' Stock will have slight differences in overall dimensions shown here. Stock: 1200(L) x 563(D)

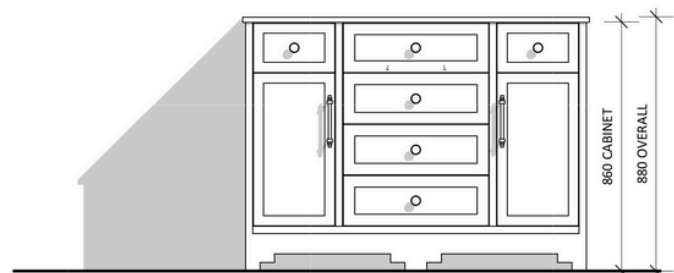
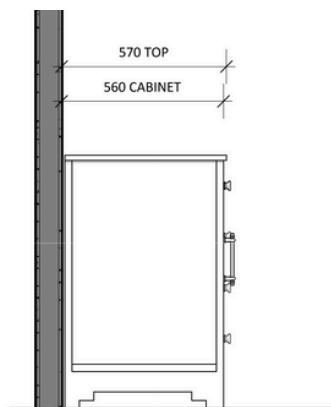
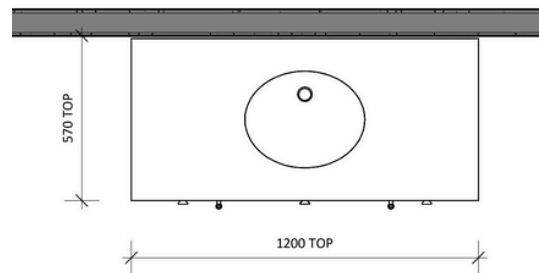
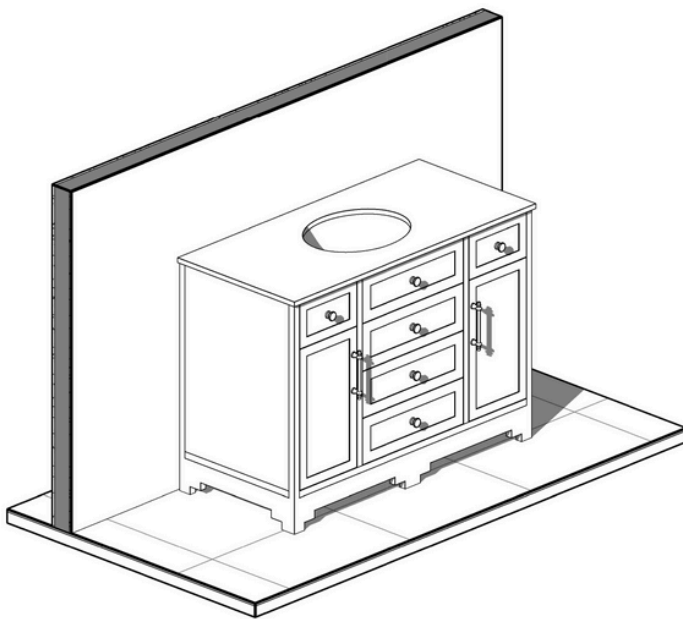

Notes:

- Wastes and faucets are not included.
- Vanity unit must be installed by a qualified tradesmen - Failure to do so will void the warranty.
- Plumbing fixtures must be installed by a qualified plumber - Failure to do so will void the warranty.
- Warranty information: 5 years on cabinet & 12 months on top and basin(s).
- Caution boxes may be heavy and will require 2 people to lift.



vanitybydesign.com.au



[vanitybydesign_](https://www.instagram.com/vanitybydesign_)



TEL: 07 [3376 6055](tel:0733766055)



241 Monier Road
Darra, QLD, 4076



Chantel

Chantel 1500 Double - 2024

Cabinet Size: 1480mm (L) X 550mm (D) X 860mm (H)

Top Size: 1500mm (L) X 560mm (D) X 20mm (H)

Type: Freestanding

Basin: Oval Under-mount Ceramic Basin

Please Note!

We have some 23' Chantel collection available for immediate pick-up.

23' Stock will have slight differences in overall dimensions shown here.

Stock: 1530(L) x 563(D)

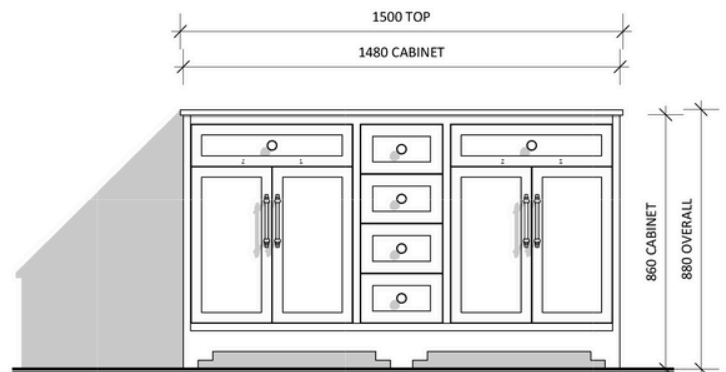
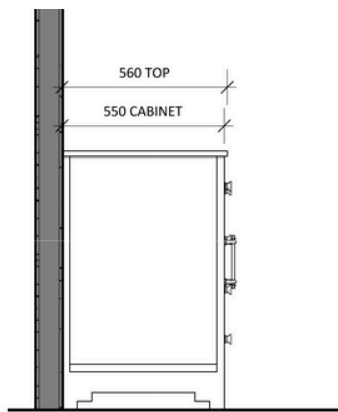
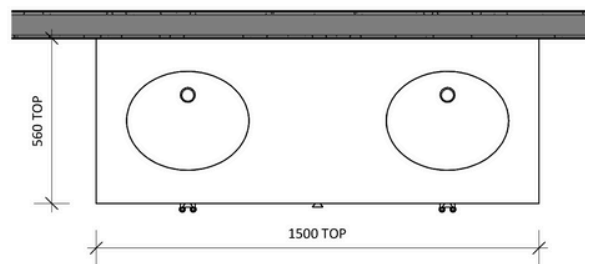
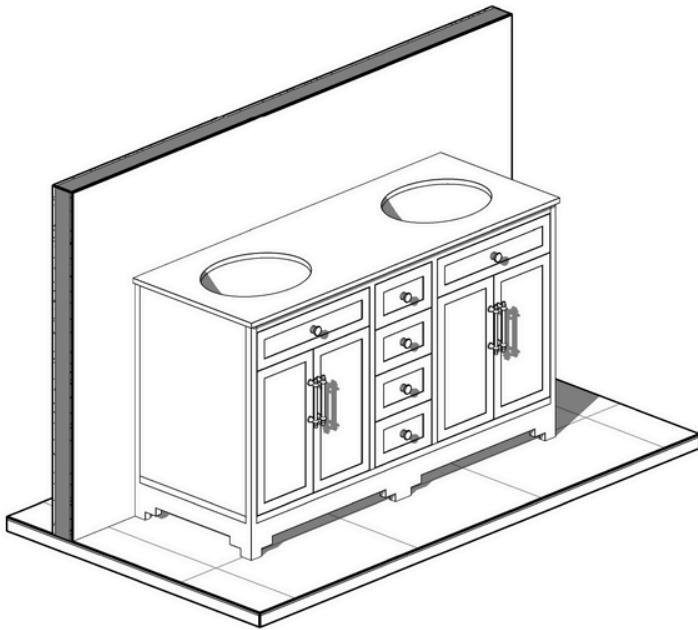

Notes:

- Wastes and faucets are not included.
- Vanity unit must be installed by a qualified tradesmen - Failure to do so will void the warranty.
- Plumbing fixtures must be installed by a qualified plumber - Failure to do so will void the warranty.
- Warranty information: 5 years on cabinet & 12 months on top and basin(s).
- Caution boxes may be heavy and will require 2 people to lift.



vanitybydesign.com.au



[vanitybydesign_](https://www.instagram.com/vanitybydesign_)



TEL: 07 [3376 6055](tel:33766055)



241 Monier Road
Darra, QLD, 4076



Rubie

Rubie 460

Overall Size: 460mm (L) X 255mm (D) X 600mm (H)

Type: Wall-Hung

*Only Suitable for Mixer Tap

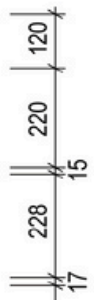
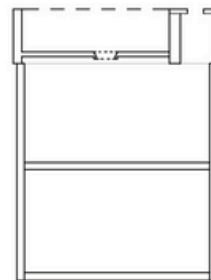
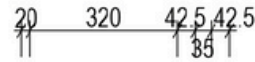
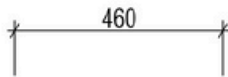
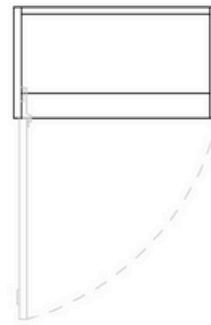
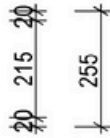
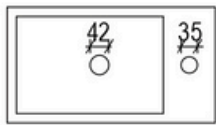
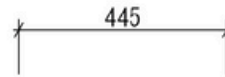
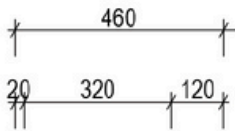
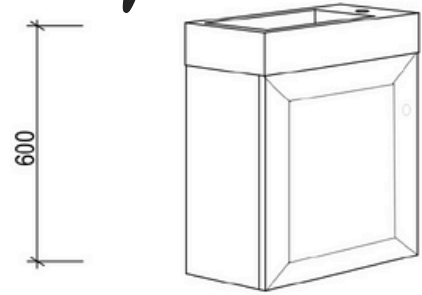

Notes:

- Wastes and faucets are not included.
- Vanity unit must be installed by a qualified tradesmen - Failure to do so will void the warranty.
- Plumbing fixtures must be installed by a qualified plumber - Failure to do so will void the warranty.
- Warranty information: 5 years on cabinet & 12 months on top and basin(s).
- Caution boxes may be heavy and will require 2 people to lift.



vanitybydesign.com.au



[vanitybydesign_](https://www.instagram.com/vanitybydesign_)



TEL: 07 3376 6055



241 Monier Road
Darra, QLD, 4076

V

Customer Photos



@stevecordony

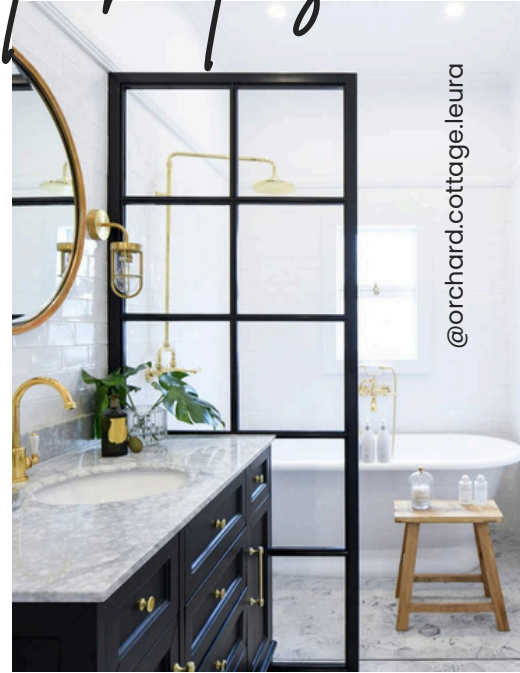

@orchard.cottage.leura



@homesbyhoven



@stevecordony

@eleanorpendleton



@stevecordony



vanitybydesign.com.au



[vanitybydesign_](https://www.instagram.com/vanitybydesign_)



TEL: 07 3376 6055



241 Monier Road
Darra, QLD, 4076