

V

Eadie

collection

20
24



House Collection

Eadie 900 Single

Eadie 1500 Double

Chelsea 460

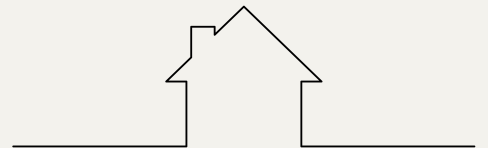

House Collection



Eadie 900 Single



Eadie 1500 Double



Chelsea 460

Cabinet Finish

-Choose your Timber Veneer | Custom Paint



Japan Black



Natural Veneer

Basin

Client to Nominate



Tommy White (Standard)

Bench Top

Subject to availability and chosen design



Cali



Blanco (White)



Brushed Gold



Brushed Nickel

Handles

Choose a finish



Eadie collection

– The Eadie showcases a contemporary design, featuring Timber Veneer finishes of Natural & Japan Black. These veneers are intricately detailed with a fine scalloped pattern, reminiscent of Art Deco-inspired interiors. Channeling the seaside glamour of "The Great Gatsby," immerse yourself in the elegance of scallop shell motifs.

Eadie 900 | Single Basin

900 Length x 460 Depth

Eadie 1500 | Double Basin

1500 Length x 460 Depth





Eadie

Eadie 900 Single - 2024

Cabinet Size: 880mm (L) X 450mm (D)
Top Size: 900mm (L) X 460mm (D) X 20mm (H)
Type: Wall Hung
Basin: Client to nominate

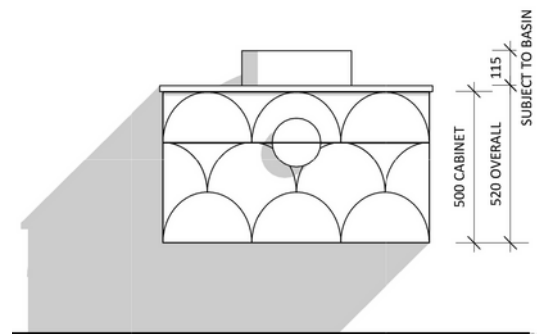
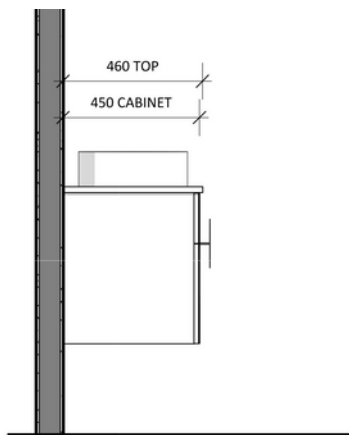
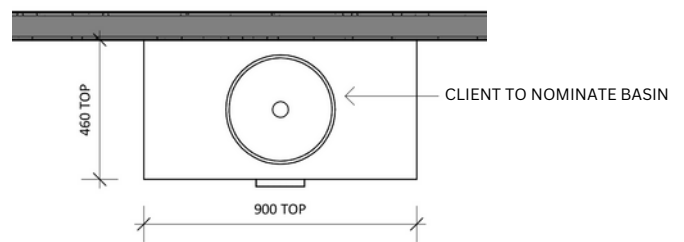
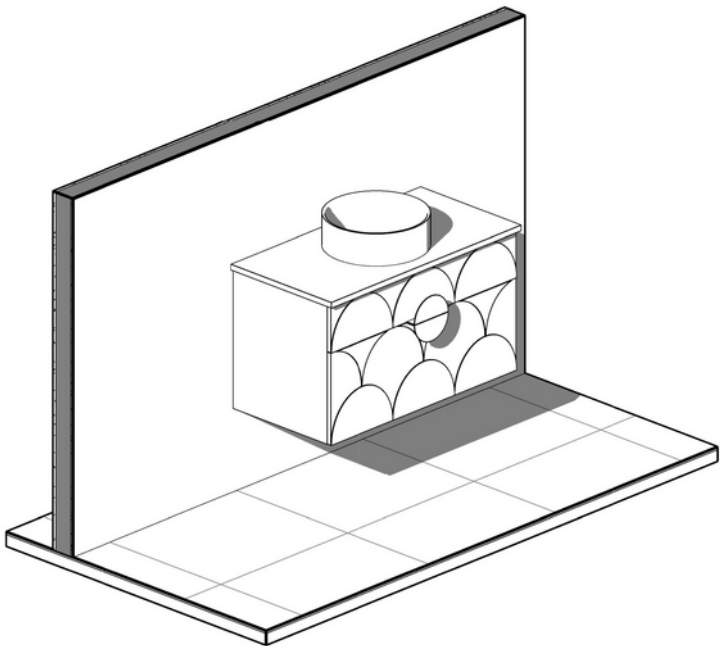

Notes:

- Wastes and faucets are not included.
- Vanity unit must be installed by a qualified tradesmen - Failure to do so will void the warranty.
- Plumbing fixtures must be installed by a qualified plumber - Failure to do so will void the warranty.
- Warranty information: 5 years on cabinet & 12 months on top and basin(s).
- Caution boxes may be heavy and will require 2 people to lift.



vanitybydesign.com.au



[vanitybydesign_](https://www.instagram.com/vanitybydesign_)



TEL: 07 [3376 6055](tel:33766055)



241 Monier Road
Darra, QLD, 4076



Eadie

Eadie 1500 Double - 2024

Cabinet Size: 1480mm (L) X 450mm (D)
Top Size: 1500mm (L) X 460mm (D) X 20mm (H)
Type: Wall Hung
Basin: Client to nominate

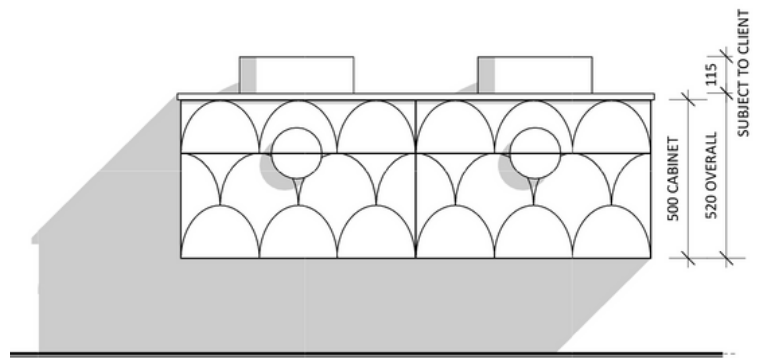
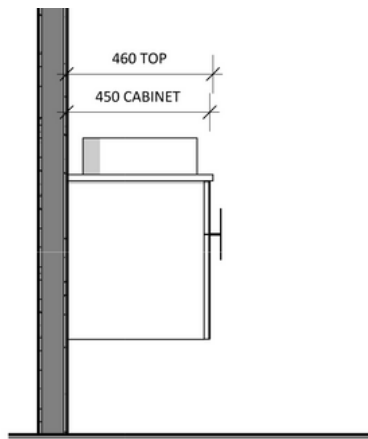
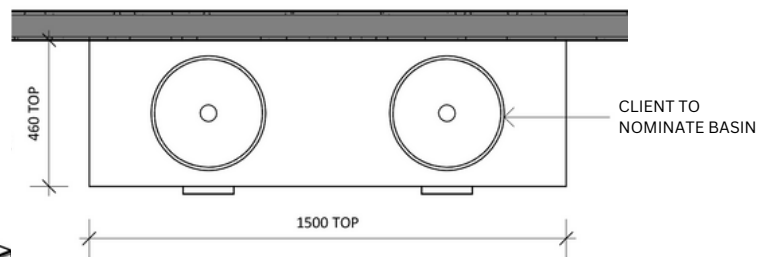
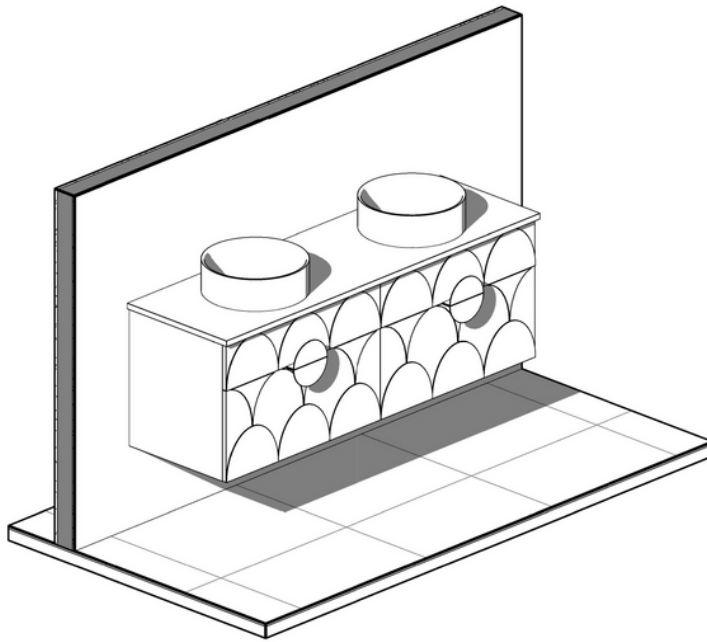

Notes:

- Wastes and faucets are not included.
- Vanity unit must be installed by a qualified tradesmen - Failure to do so will void the warranty.
- Plumbing fixtures must be installed by a qualified plumber - Failure to do so will void the warranty.
- Warranty information: 5 years on cabinet & 12 months on top and basin(s).
- Caution boxes may be heavy and will require 2 people to lift.



vanitybydesign.com.au



[vanitybydesign_](https://www.instagram.com/vanitybydesign_)



TEL: 07 [3376 6055](tel:33766055)



241 Monier Road
Darra, QLD, 4076



Chelsea

Chelsea 460

Overall Size: 460mm (L) X 255mm (D) X 600mm (H)

Type: Wall-Hung

*Only Suitable for Mixer Tap

Finish - Natural & Japan Black

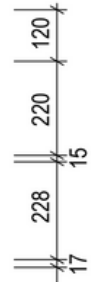
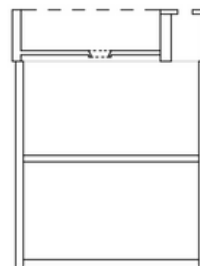
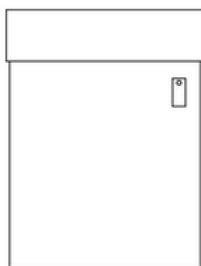
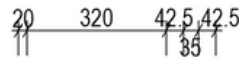
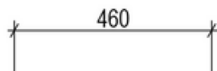
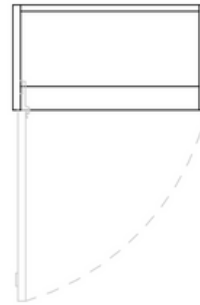
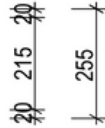
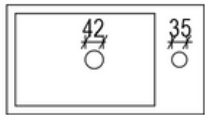
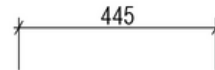
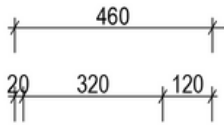
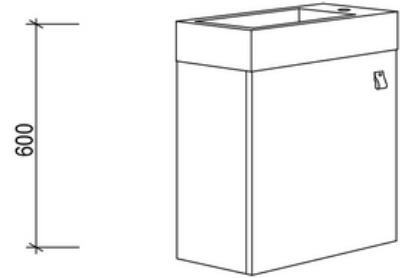

Notes:

- Wastes and faucets are not included.
- Vanity unit must be installed by a qualified tradesmen - Failure to do so will void the warranty.
- Plumbing fixtures must be installed by a qualified plumber - Failure to do so will void the warranty.
- Warranty information: 5 years on cabinet & 12 months on top and basin(s).
- Caution boxes may be heavy and will require 2 people to lift.



vanitybydesign.com.au



[vanitybydesign_](https://www.instagram.com/vanitybydesign_)



TEL: 07 [3376 6055](tel:33766055)



241 Monier Road
Darra, QLD, 4076

V



vanitybydesign.com.au



[vanitybydesign_](https://www.instagram.com/vanitybydesign_)



TEL: 07 3376 6055



241 Monier Road
Darra, QLD, 4076