



V

*Airlie*  
collection

20  
24



**House Collection**

Airlie 900 Single

Airlie 1500 Double

Lucie 460

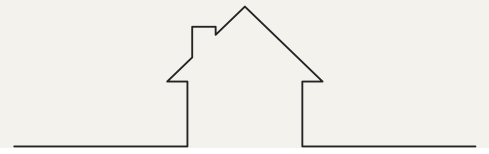

# House Collection



Airlie 900 Single



Airlie 1500 Double



Lucie 460

## Cabinet Finish

-Choose your paint finish | Custom Paint

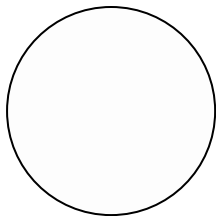

White

## Basin

Client to Nominate



Tommy White or Black (Standard)

## Bench Top

Subject to availability and chosen design



**Snow-Blanc**

Crystalline Silica-Free (Engineered Stone)



**Ayla**

Crystalline Silica-Free (Engineered Stone)

## Handles

Choose a finish



Brushed Gold



Brushed Nickel





# Airlie collection

– a harmonious blend of relaxed design, subtle VJ paneling, and a contemporary round handle. Immerse yourself in luxury as you capture the essence of coastal or cottage charm, delivering a refreshing and sophisticated touch to your space.

## **Airlie 900 | Single Basin**

900 Length x 460 Depth

## **Airlie 1500 | Double Basin**

1500 Length x 460 Depth

### **Please Note!**

2024 Collection varies from previous models. The New Collection has drawers instead of cupboards to provide a more practical solution!



# Airlie

## Airlie 900 Single - 2024

Cabinet Size: 880mm (L) X 450mm (D) X 500mm (H)  
 Top Size: 900mm (L) X 460mm (D) X 20mm (H)  
 Type: Wall Hung  
 Basin: Client to nominate  
 No Tap Holes, Tapware to be wall-mounted

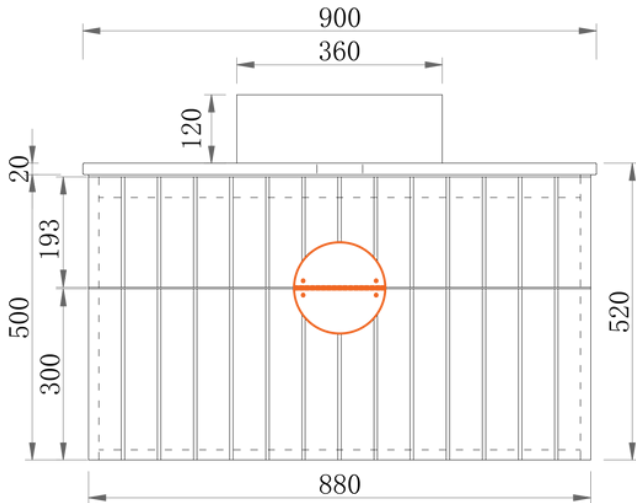
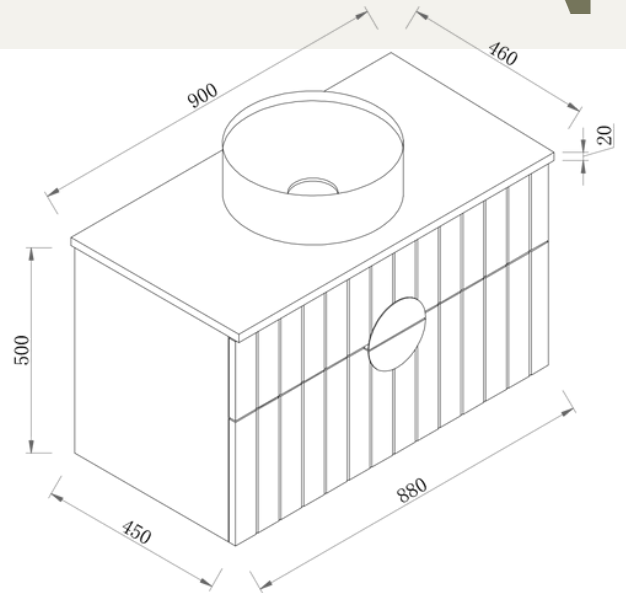

Front Elevation

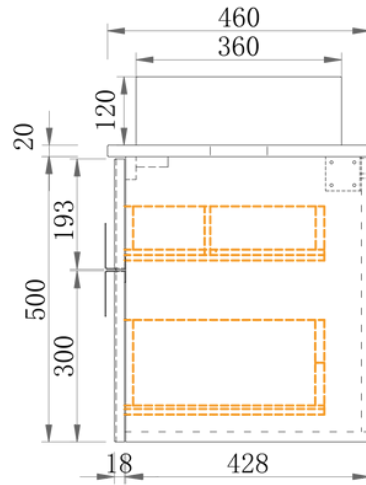

Section Side

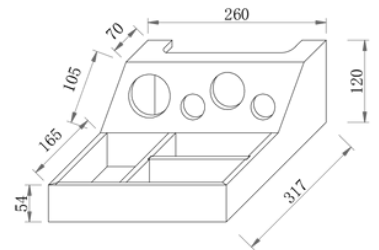

Hairdryer Insert  
(Lower Drawer)

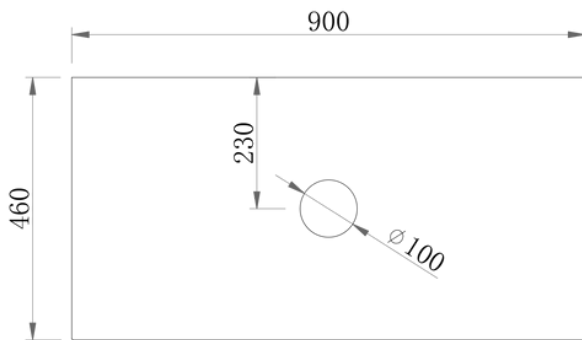

Top View

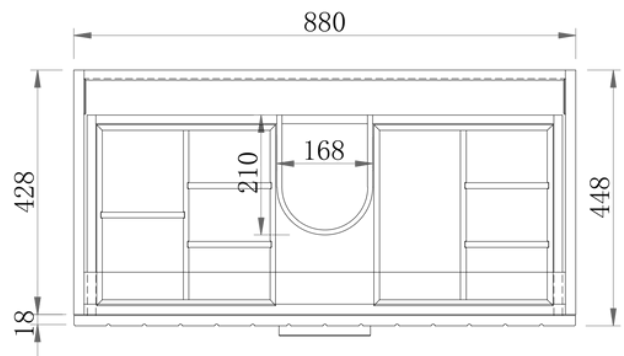

Section Top - Drawer Inserts

**Notes:**

- Wastes and faucets are not included.
- Vanity unit must be installed by a qualified tradesmen - Failure to do so will void the warranty.
- Plumbing fixtures must be installed by a qualified plumber - Failure to do so will void the warranty.
- Warranty information: 5 years on cabinet & 12 months on top and basin(s).
- Caution boxes may be heavy and will require 2 people to lift.





# Airlie

## Airlie 1500 Double - 2024

Cabinet Size: 1480mm (L) X 450mm (D) X 500mm (H)  
 Top Size: 1500mm (L) X 460mm (D) X 20mm (H)  
 Type: Wall Hung  
 Basin: Client to nominate  
 No Tap Holes, Tapware to be wall-mounted

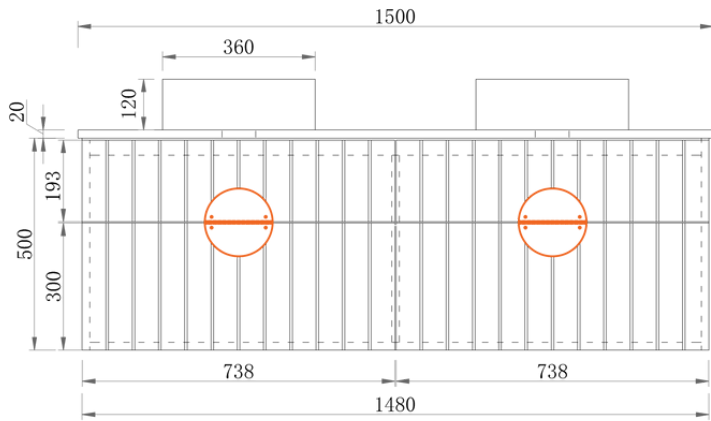
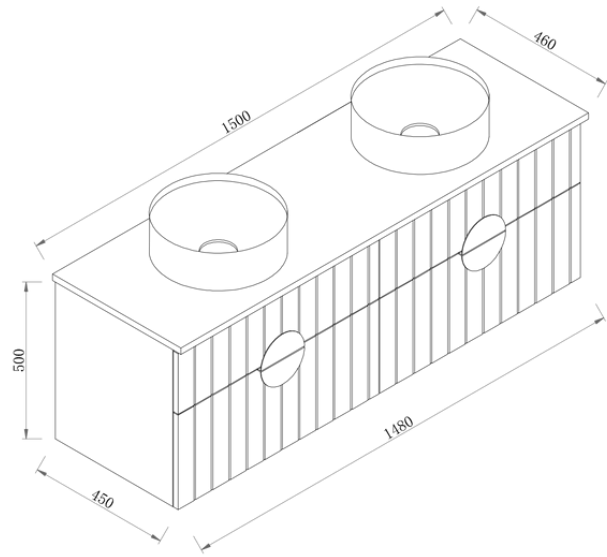

Front Elevation

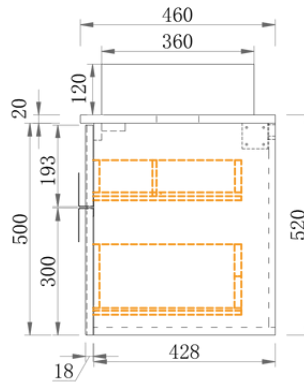

Section Side

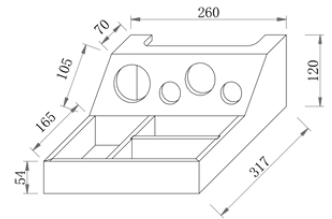

Hairdryer Insert  
(Lower Drawer)

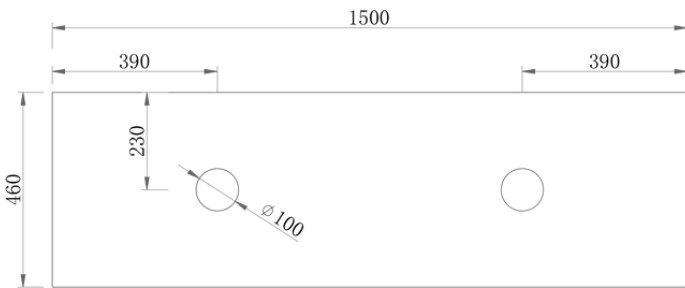

Top View

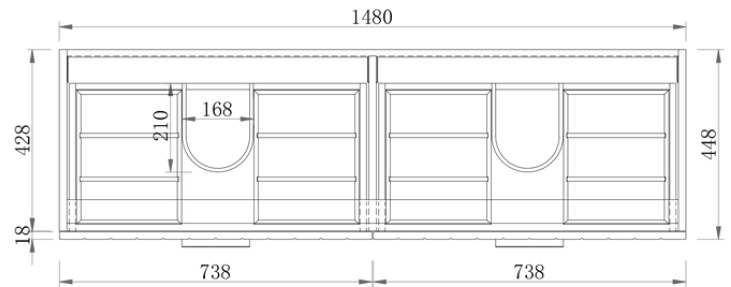

Section Top - Drawer Inserts

### Notes:

- Wastes and faucets are not included.
- Vanity unit must be installed by a qualified tradesmen - Failure to do so will void the warranty.
- Plumbing fixtures must be installed by a qualified plumber - Failure to do so will void the warranty.
- Warranty information: 5 years on cabinet & 12 months on top and basin(s).
- Caution boxes may be heavy and will require 2 people to lift.



vanitybydesign.com.au



vanitybydesign\_



TEL: 07 3376 6055



241 Monier Road  
Darra, QLD, 4076



# Lucie

## Rubie 460

Overall Size: 460mm (L) X 255mm (D) X 600mm (H)

Type: Wall-Hung

Custom Paint Options

\*Only Suitable for Mixer Tap

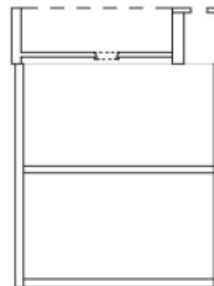
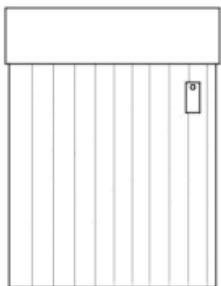
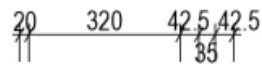
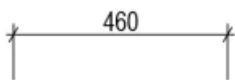
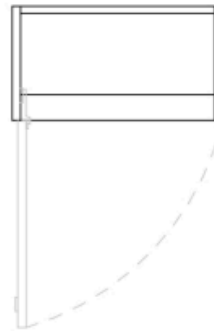
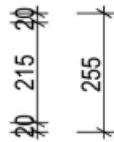
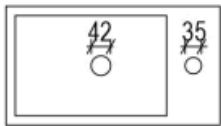
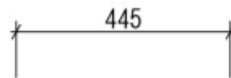
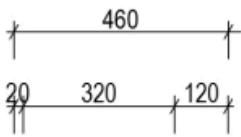
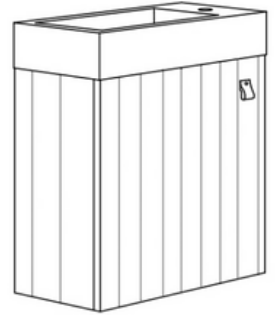

### Notes:

- Wastes and faucets are not included.
- Vanity unit must be installed by a qualified tradesmen - Failure to do so will void the warranty.
- Plumbing fixtures must be installed by a qualified plumber - Failure to do so will void the warranty.
- Warranty information: 5 years on cabinet & 12 months on top and basin(s).
- Caution boxes may be heavy and will require 2 people to lift.



[vanitybydesign.com.au](http://vanitybydesign.com.au)



[vanitybydesign\\_](https://www.instagram.com/vanitybydesign_)



TEL: 07 [3376 6055](tel:33766055)



241 Monier Road  
Darra, QLD, 4076



[vanitybydesign.com.au](http://vanitybydesign.com.au)



[vanitybydesign\\_](https://www.instagram.com/vanitybydesign_)



TEL: 07 3376 6055



241 Monier Road  
Darra, QLD, 4076